

SELECT CAM ADAPTER

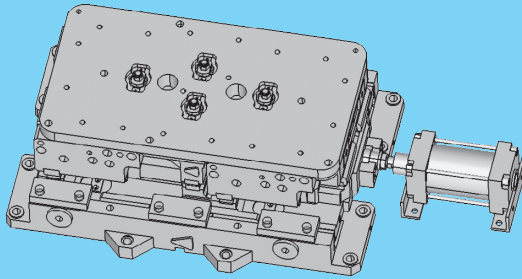

— REGULAR TYPE —
SCA-S115-L40-WT65

— LARGE TYPE —
SCA-S115-L40-WT300

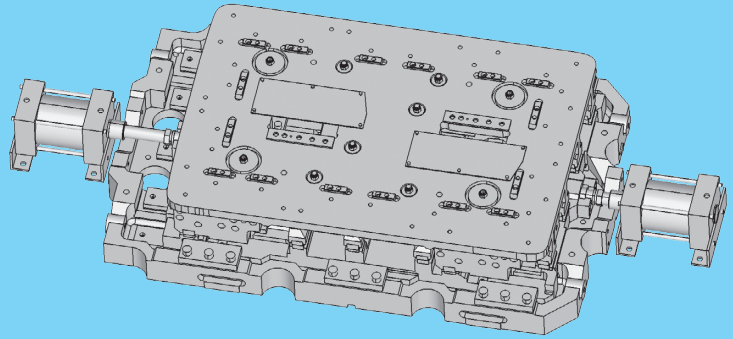

■ Variety of the “SCA” Series.

TYPE	Reference Width A.	Reference Length B.	Reference Lock Height C.	Lift Up&Down Travel	Slider Travel D.
	(mm)	(mm)			
REGULAR	370	800	330	40	115
LARGE	895	1315			

— REGULAR TYPE —

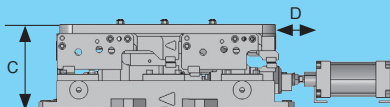
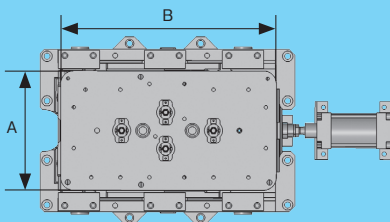

— LARGE TYPE —

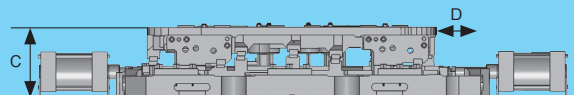
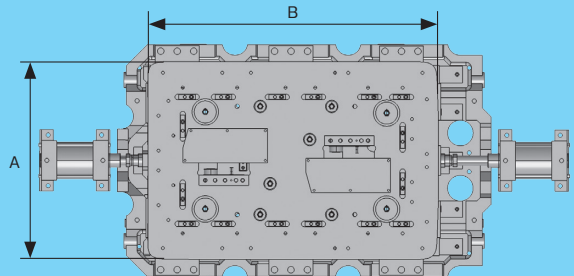

■ Characteristic

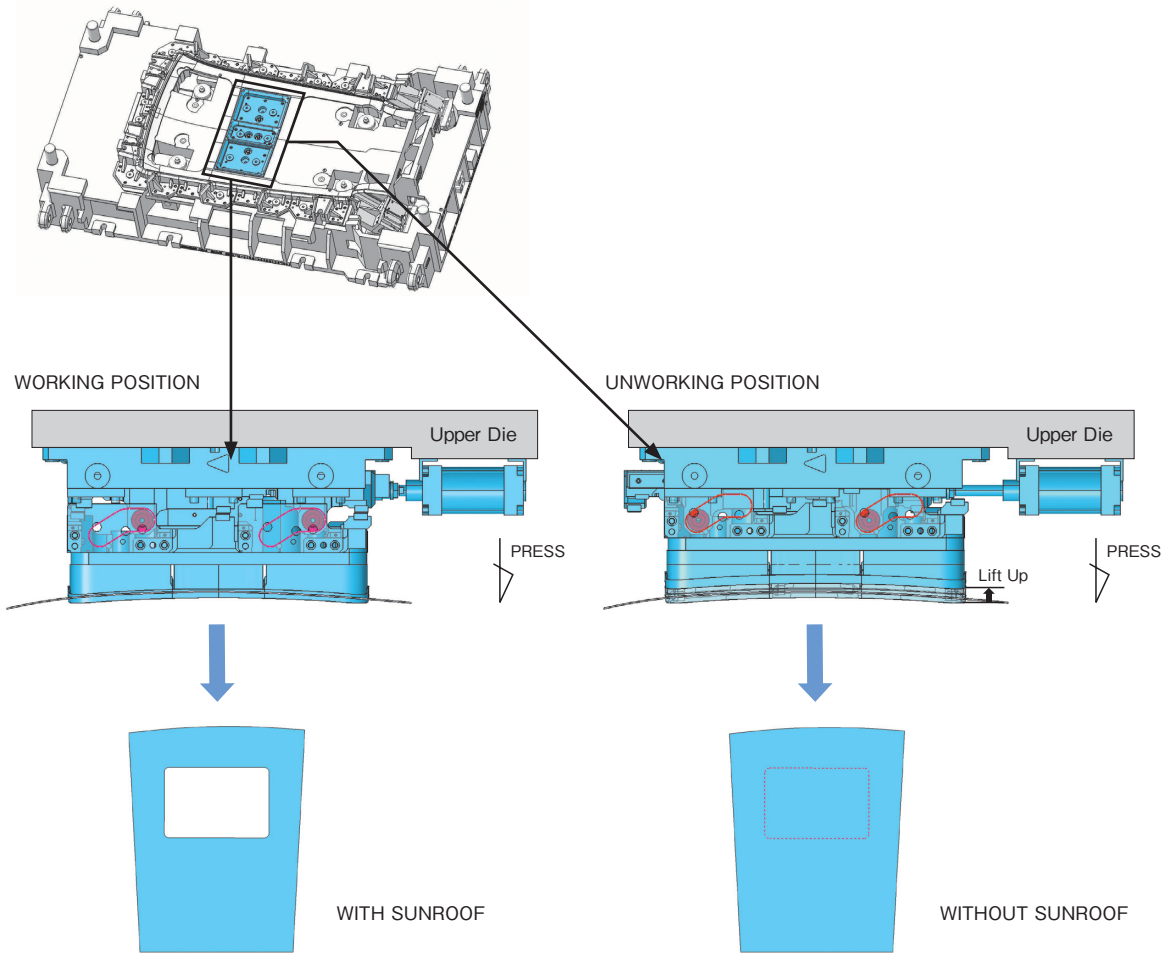

■ How to order.

The product is to be custom manufactured to the specific part geometry.
 Please contact us. (E-mail : sales@umix.co.jp)